

FUTON SOFA BED

Build a convertible couch in the Craftsman style

By John Kriegshauser



Photos, Russell Phillips, Chicago Photographic Co.

Unlike low-slung commercial models, this comfortable upright futon sofa makes it easy to rise to a standing position. The oak frame has mortise-and-tenon joinery and barely visible hardware. The plain canvas cushion is sheathed in a fabric cover that can be removed for laundering. You'll find cushions that will fit this futon frame at department stores and specialty stores.

For years I wanted to build a sofa, but my lack of upholstering skills discouraged me. Then inspiration struck when I sat on a friend's futon sofa bed. It was cheaply made and not very comfortable, but the potential was obvious. I could build my own futon frame and buy the cushion.

To learn more, I visited a futon store and sat on several deep, low-slung models that were comfortable to lounge in but tricky to get back out of. They had been simplified for mass production with screws and staples instead of joinery.

My demanding taste in woodworking led me to create my own design. My futon is for the living room instead of the rec room, and it is solidly constructed. I built it out of solid oak with mortise-and-tenon construction and incorporated elements of the mission style in the side assemblies. If you prefer a different style, you can change the design of the

side assemblies — just respect the spread of the feet and the location of the track slots so your sofa will have standard seat angles and a stable bed platform.

Because the size of futon cushions varies, it's smart to buy one before you begin construction (see "Selecting a Futon Cushion," p. 41). I bought a full-size cushion that measured 54-3/4 x 74 in. and was 8 in. thick. If your cushion is a different size, alter the plan's dimensions accordingly.

To build this futon, you'll need the following lumber:

Thickness	Actual Amount	+ 25% Waste
1 in. (4/4)	21 board ft.	26 board ft.
1-1/4 in. (5/4)	9 board ft.	11 board ft.
1-1/2 in. (6/4)	10.5 board ft.	13 board ft.
2 in. (8/4)	8.8 board ft.	11 board ft.

(To be on the safe side, buy enough lumber to allow for 25 percent waste.) In addition, you'll need a well-equipped shop and some previous furniture-making experience.

Before you begin joinery, mill all the parts to thickness. You might want to start with stock that's a little longer than necessary (particularly for the legs).

MORTISE-AND-TENON JOINTS

All the mortises in this design have straight lines, which makes them easy to cut. I used a router with a single-flute 3/8-in. carbide bit for all but the deep leg/rail mortises. For those I used a 1/2-in. single-flute bit. Even in hard oak, I could make 1/4-in.-deep passes with my heavy-duty plunge router.

To make cutting the mortises easier, I abandoned the manufactured router fence and attached a substitute base made from medium-density fiberboard to my plunge router. Then I clamped a wood fence to the base at an angle that allowed me to grip the router handles and view the cut easily while standing next to the part (photo 1, p. 41).

Expensive joint-making machines or tenon-cutting devices are great, but you can make a simple, inexpensive tenon-



With the cushion removed, the ribs are revealed. They provide plenty of strength for a heavy load, but because they're not too thick (1/2 in.), they're also flexible. Note that the hinges barely protrude above the surface.



A simple mechanism enables you to fold the sofa out to make a bed when company arrives.



The kink in the tracking slot helps slow the descent of the back frame when the sofa is converted to a bed. Note the blocking member attached to the back rib.

cutting fixture for your table saw in a few hours (photo 2). Cutting tenons with a table saw leaves square corners. You don't need to meticulously fit these into the round mortise corners; just shave off the tenon corners with a quick chisel stroke (photo 3). To make insertion a little easier, slightly bevel the front edges of the tenons.

DOWELED CONNECTIONS

The seat- and back-frame corner connections must withstand tremendous stress when people sit on the sofa. Many cheap manufactured frames fail at these corners. The connections at the hinge rail **B** (see drawing, p. 40) of the seat frame are perilously close to the tracking pins, which are also major stress points.

I decided to join these parts with three dowel pins (photo 4, p. 42) because dowels are less likely than mortise-and-tenon joints to provide origin points for cracks. To further reinforce the sofa, I added two pieces of blocking **G,H** under the ribs of the back frame and seat frame.

These blocking pieces rest on the stout sofa rails **I**, so the weight of a person sitting in the middle of the sofa will be supported by the sofa rails instead of putting stress on the frame corner joint.

TRACKING PINS

Whatever load is not borne by the sofa rails will be carried by the tracking pins. Many well-manufactured sofas have steel tracking pins, which never wear down or become crushed. I couldn't find a source for steel pins, so I used maple dowels, which should have an acceptable service life. To support heavy loads, the pins should be made from 1-in.-dia. dense maple dowels and fit snugly into cleanly drilled 1-in. holes. I wedged the back of each pin (Detail 2) for a stronger bond. To do this, first use a band saw to cut a 1-in.-deep kerf along the center of the dowel and then make a thin, steeply angled wedge to drive into the kerf (photo 5). After slathering both the dowel surface and the interior of the hole with glue, insert the dowel into the hole

and drive the wedge home, flaring the dowel for a tighter fit.

BED-RAIL HARDWARE

Visible bolts and screws would diminish the formality of this sofa, so I opted for old-fashioned fully concealed bed-rail hardware (see Where to Find It, p. 42) to connect the frames and sides.

To install bed-rail fasteners (Detail 4), first rout a 5/8-in.-wide x 5-in.-long mortise the same depth as the thickness of the steel plate for the male part on the end of each sofa rail. Square the corners of the mortise with a chisel. Be careful — this is thin-walled end grain. To accommodate the rivet heads in the hardware, cut depressions in the appropriate places with a carver's gouge. Then screw the hardware in place with no. 8 x 1-1/4-in. flathead wood screws.

Positioning the female part is tricky. Label the leg blanks **J** right and left and position the hardware accordingly. You may need to fine-tune the hardware and

Continued on p. 41

FUTON SOFA BED

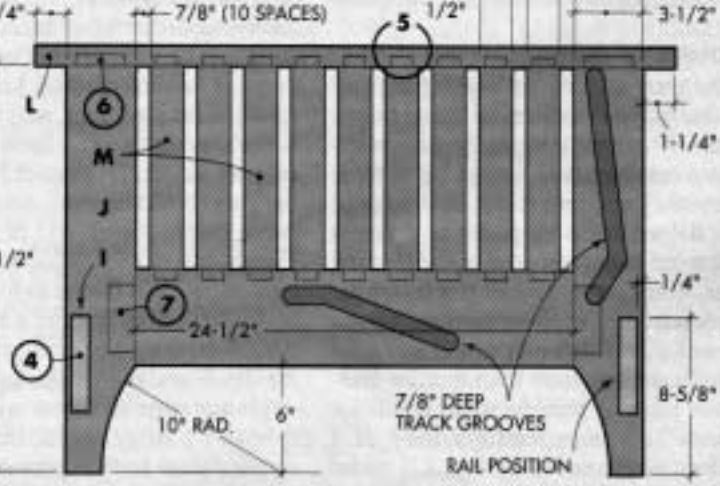
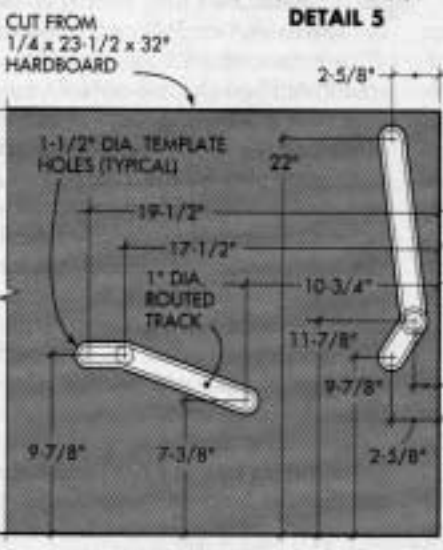
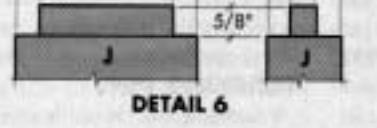
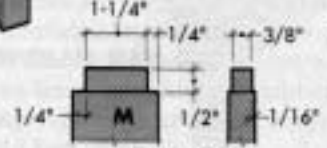
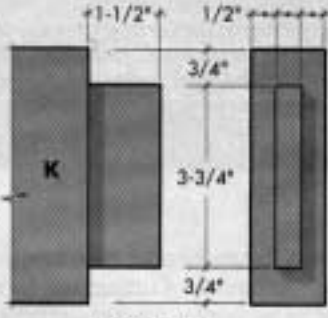
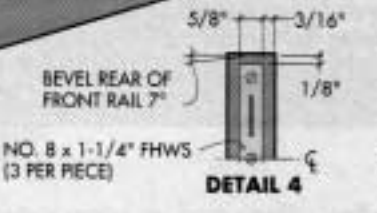
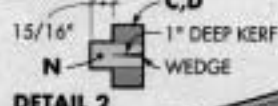
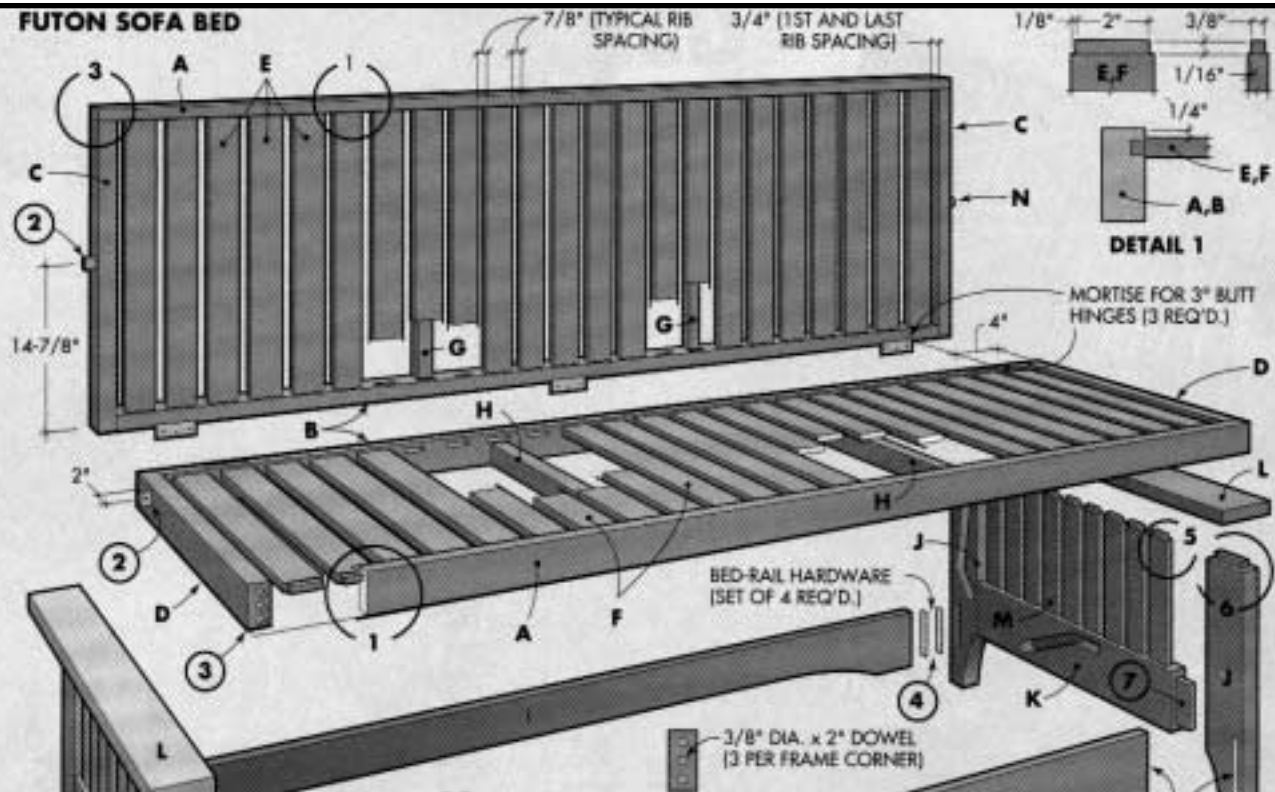

Technical drawing: Eugene Thompson

TEMPLATE FOR ROUTING TRACKS

SIDE SECTION VIEW

Continued from p. 39

the hardware installation so the parts fit and lock properly and to ensure the rail is a consistent height. Because each set of hardware locked at a slightly different level, I made the leg blanks about 1/2 in. longer than was necessary and installed the female parts 8-3/4 in. up from the bottom of the blank. That way I could trim the legs so that the rails would be parallel with the floor.

Next, you must cut slots to accommodate the hooks on the male part. Because the slots are so close to the anchoring screw holes, I cut the slots with a drill press, which affords a great deal of control. Mount a 1/4-in. solid-carbide spiral router bit in the drill press and place the leg on the drill press table against a fence (photo 6). Use the bit first as a drill to remove most of the waste and then as a router to remove the remainder of the waste. Slide the piece against the fence while making successively deeper passes in the mortise.

To lock properly, the female parts must be recessed below the surface of the wood in varying amounts (photo 7). Achieving the right depth can be a time-consuming trial-and-error procedure. (Note: At this point the male and female parts are uniquely paired, so I stamped identification numbers on them.)

With the female half of the connector installed you can complete the necessary adjustments. Lock the sofa rail into the leg and mark the resting height of the rail's top edge. Then trim off the end of the leg blank 8-5/8 in. down from this mark. Finally, cut the leg so it's 23-1/8 in.

SELECTING A FUTON CUSHION

Shoppers have a variety of elements to consider when buying a futon cushion. First, determine the size you need. Standard cushions come in mattress sizes (twin through king); some companies will make custom sizes. In addition to size, it's important to know what thickness you prefer. Joe Totulli, publisher of *Futon Life* magazine, says a 7- or 8-in.-thick cushion is adequate for use as a sofa, but if you plan to use your futon as a bed, he suggests you buy an 8- or 10-in.-thick cushion.

Cushions are made of a variety of materials. The firmest cushions are made of 100 percent cotton. Cushions made from combinations of cotton, foam, polyester materials and wool are softer and more resilient. Some stores display cutaways of cushions, which show the various layers. Depending on the blend of materials, size and thickness, Totulli says consumers should expect to spend about \$80 to \$230.

For safety reasons, before purchasing a futon, always ask suppliers if their products meet all federal flammability standards administered by the Consumer Product Safety Commission.

Futon covers protect cushions from dirt and wear. They cost from \$50 to \$200 and come in solid colors and designer prints. A cover is not necessary if you're using the futon as a bed only; however, a fitted sheet or mattress cover is recommended.

To locate futon suppliers in your area, check your local Yellow Pages under the headings for Futons, Bedding and Furniture Dealers. You can also order by mail from The Unmade Bed, Dept. WB, 10921 Elm St., Rockbrook Village, Omaha, NE 68144; (402) 397-9340. Futon cushions from The Unmade Bed cost between \$100 and \$600.

For more information about futons, write the Futon Association of North America, Futon Info., Dept. WB, Box 6548, Chico, CA 95927. — Kip L. Chin

long. This puts the sofa rails at the precise height to support the seat and back frames when they are lowered into the bed position.

GLUING

Because of the large number of joints, whenever possible I glued each element of the sofa in manageable stages. For example, to assemble the sides, first glue the spokes **M** to the arms **L**. Squirt glue into the spoke mortises under the arms, leaving the other mortises dry. Then use a stick the size of a tongue depressor to smear the glue on the walls of each mortise. To avoid unsightly glue squeeze-out, leave the tenons dry and quickly clamp the entire side assembly together.

When the glue has dried, disassemble

the remaining dry joints, smear glue in the mortises and on the cheeks of the leg/rail tenons and clamp the side assembly. I applied glue to the cheeks of the large tenons because of their vital structural role and because the glue squeeze-out from these large joints can be easily cleaned off later.

ROUTING THE TRACKS

The tracks are the key element in the folding mechanism. I carefully made a 1/4-in. hardboard template to guide the router when cutting the tracks (see drawing). To cut the 1-in.-wide slots in the side legs **J** and side rails **K**, I used a 1/2-in.-dia. router bit in a router equipped with a 1-in.-outside-diameter guide bushing. To accommodate the off-

CUTTING LIST: FUTON SOFA BED

(all parts oak except as noted)

Key No.	Part, Mat'l.	Size
A	2 Long rails, seat and back	1-1/8 x 2-1/2 x 74-7/8"
B	2 Hinge rails, seat and back	1-1/8 x 2-1/2 x 72-1/2"
C	2 Back side rails	1-3/16 x 2-1/2 x 27-1/8"
D	2 Seat side rails	1-3/16 x 2-1/2 x 24-5/8"
E	23 Back ribs	1/2 x 2-1/4 x 26-3/4"
F	23 Seat ribs	1/2 x 2-1/4 x 24-1/4"
G	2 Back blocking	1-1/4 x 1-3/4 x 26"
H	2 Seat blocking	1-1/4 x 1-3/4 x 23-1/2"
I	2 Front and back sofa rails	1 x 5-1/4 x 75"
J	4 Side legs	1-1/2 x 3-3/4 x 23-1/8"
K	2 Side rails	1-1/2 x 5-1/4 x 27-1/2"
L	2 Side arms	1 x 3-1/2 x 35-1/2"
M	18 Side spokes	1/2 x 1-3/4 x 12-1/4"
N	4 Tracking dowels	1" dia. x 2-1/8"

Misc.: 3/8" dia. x 2" fluted dowels (24); 2-1/2 x 3" long fixed-pin brass butt hinges (3); 5" long bed-rail hardware (set of 4; see *Where to Find It*); no. 8 x 1-1/4" FHWS (24).



1 An angled fence clamped onto the router base makes the handles more accessible and provides an unobstructed view of the work.

2 The author made a tenon-cutting fixture to fit his table saw. If you make one, the carriage should slide smoothly in the miter



3 With a few strokes of the chisel you can cut away the edges of the tenons to fit the routed mortises. But pay attention to the grain. If it's not straight, you might remove more stock than you intended.



Black-and-white photos by the author.



4 Make a drill bushing on the drill press to accurately locate the three dowel holes at each corner of the seat frame and back frame. Use stock of the same width as the parts to ensure alignment.
5 The maple tracking pins are wedged and glued into their holes. Be sure the wedge kerf in the pin



isn't parallel to the grain of the rail or you could split the wood.
6 Use the drill press to mortise the access slots for the bed-rail hardware using a spiral router bit. Make successive passes with the bit to reach the desired depth.



7 The female part of the bed-rail connector is mortised into the sofa leg. Each bed-rail part must be fitted and labeled for its position (see text).
8 Lay out the track routing template carefully. Bore the 1-1/2-in.-dia. holes first. Then cut away most of the waste with a sabre saw. Be careful to stay



inside the layout lines — if the track is too wide, the bed's folding action will be sloppy.
9 Next, use a shooting board to connect the edges of the drilled holes. Back up the template with a piece of scrap plywood to prevent damaging your bench. Patience and accuracy are important here.

set of the bushing, I had to add 1/4 in. to each edge of the template slots, which made them 1-1/2 in. wide.

The first task in making the template is to cut smooth arcs at the critical transition points. Begin by drilling each point with a 1-1/2-in. Forstner drill bit. For the drill press to reach the seat track holes you may need to cut an access gap in the lower edge of the template so it clears the drill press column (photo 8). The track for the back-frame dowel is kinked to break its fall when the sofa is converted to a bed.

Complete the template by cutting away the material between the drilled holes. I made a router shooting board and patiently lined it up parallel to the holes. I took my time with this process and cut the straight portions of the template as accurately as I could. If you cut the template too wide, the bed's folding action will be sloppy; if you cut it too narrow, the action will be stiff or the bed may not fold out at all.

Once you've assembled the sofa sides, you need to rout the tracks. Remember, one is left-handed and the other is right-handed. Clamp the template so the lower edge is even with the bottom of the legs and the back edge is even with the rear leg. Small discrepancies along the other edges can be ignored. Pick a bit long enough to pass through the template and make a 7/8-in.-deep cut (photo 9). Do this in stages. I used a fixed-base router for this operation, but a plunge router would have been better if I had the appropriate bushings.

FINISHING

Mission furniture was definitely conceived with the craftsman in mind. You can sand most surfaces of the sofa prior to assembly. I sanded all the visible parts with 220-grit and the others with 150-grit sandpaper. Round all corners and edges, particularly if you're using a wood that tends to splinter, as oak does.

I tried several colors and brands of stain before I settled on Carver Tripp's

American Walnut because the color was appropriate and didn't bleed back. It took a lot of time to coat and wipe around all the ribs, so I was thankful that the stain allowed a long open time.

I let the stain dry for 24 hours and then applied two coats of lacquer sanding sealer. I sanded the raised grain with no-load (stearated) sandpaper. Finally, I applied three coats of satin lacquer. Other coatings — varnish or water-base finish — will work just as well as lacquer. Whatever finish you use, make sure it has a satin sheen. A glossy finish would look wrong on a mission-style piece. **W** John Kriegshauser teaches woodworking to architects at the Illinois Institute of Technology in Chicago.

WHERE TO FIND IT

5" long bed-rail fittings, catalog no. 27101, \$7.95 for a set of 4.
WOODCRAFT, Dept. WB, 210 Wood County Industrial Park, Box 1685, Parkersburg, WV 26102-1686; 800-225-1153.