

Futon Life ^{FL}

The Simple Tri-fold

This is the most basic of frames. These instructions may also be adapted to the popular "L" or simple bi-fold as well.

Parts List:

6 base boards
(all the same or four regular and two longer)

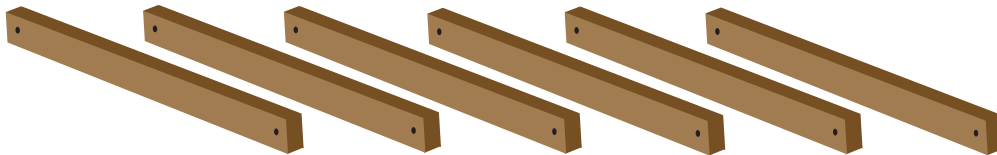

3 slat racks
(these will typically be held together with strapping or webbing material)

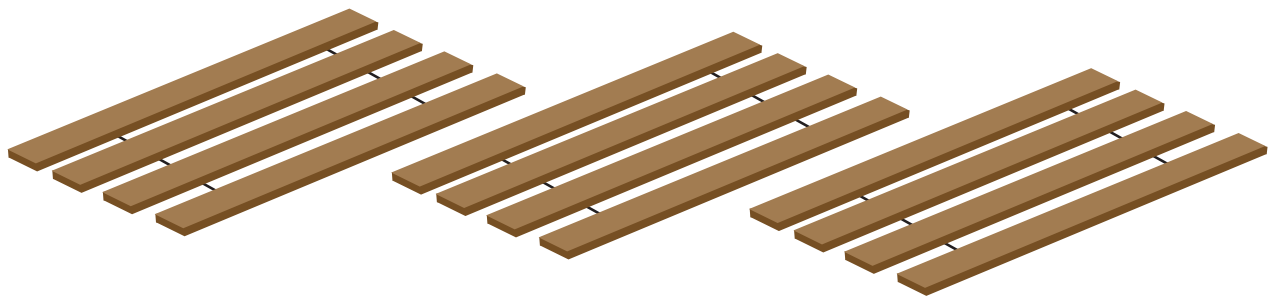

12 wood screws

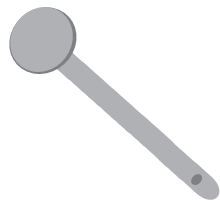

4 clevis pins



4 cotter pins

Assembly Instructions:

1 Place the six base boards as shown

NOTE: If your frame has two longer base boards they will go in the middle section. Be sure to determine if they go inside or outside the other base boards. You will also have the same issue with the slat sections. One will be longer. Placing the longer slat rack on the middle base boards and lining up the screw holes will help you determine whether this section goes inside or outside the shorter sections.

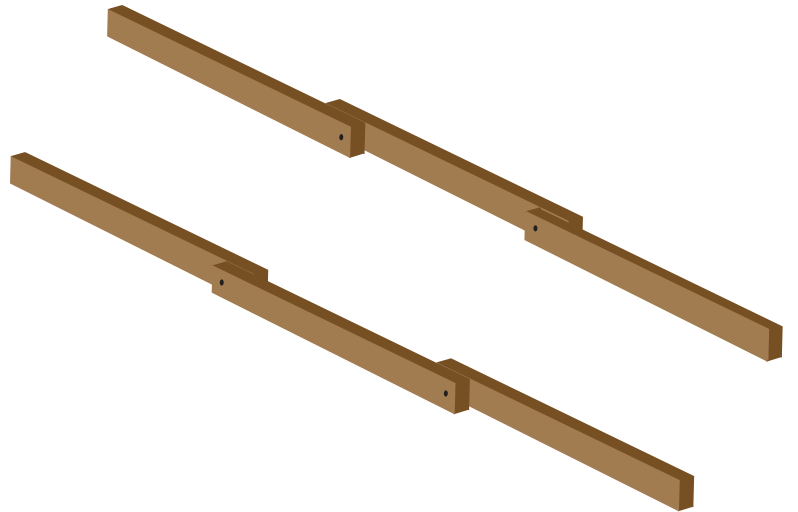

2 Line up the holes as shown and secure each hinge point with a clevis pin and cotter pin. This is the base of the frame.

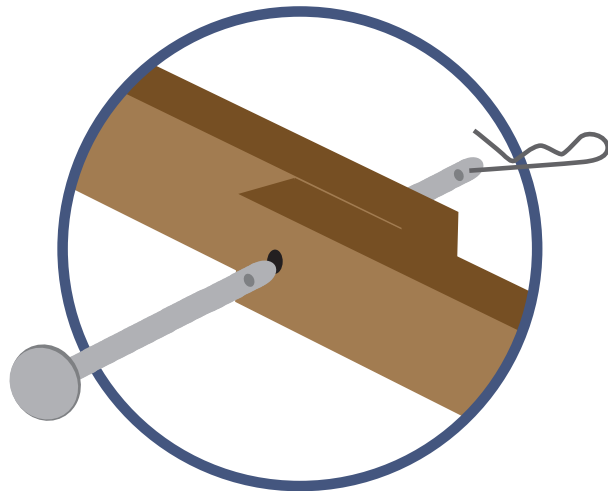

3 Place a slat rack on top of the first section of the base as shown, and secure with wood screws. Follow this same process for the other two sections.

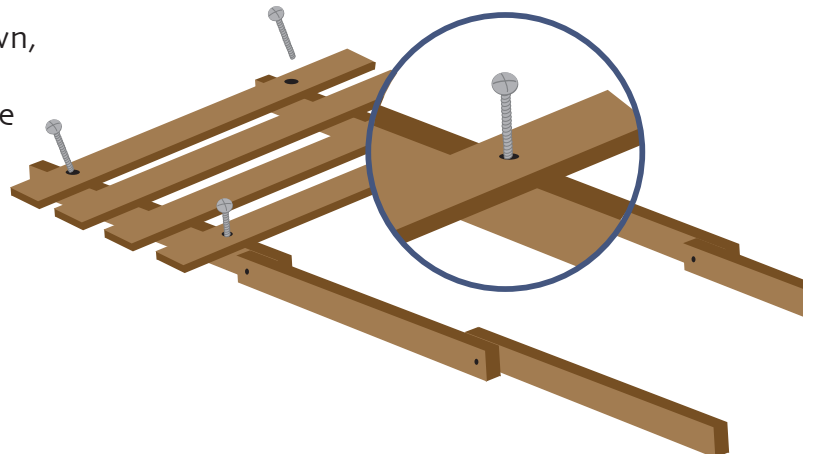

4

You can now fold your frame into the sitting position and place the futon mattress on it.

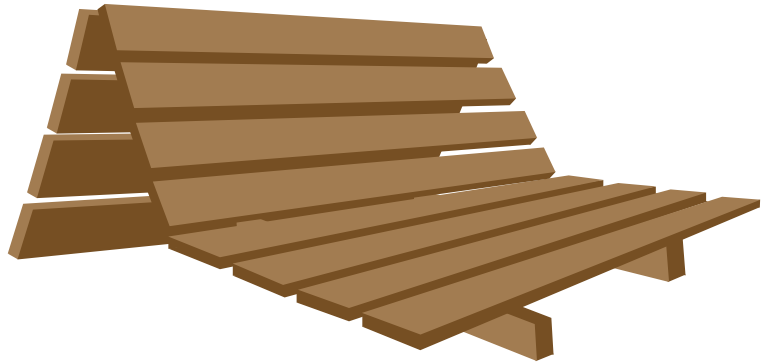
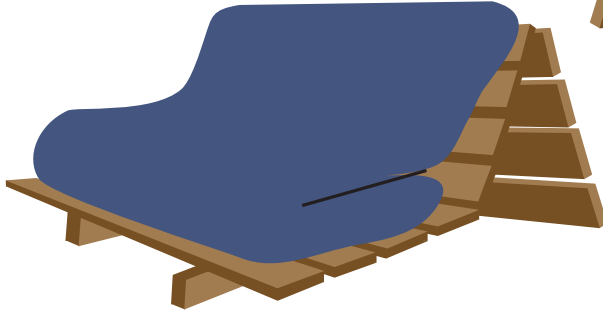

This information is copyright of Futon Life and RTP Publications, Inc and is intended for informational purposes only. Any commercial use or reproduction is expressly prohibited. All rights reserved.